

S+M

RECOVERY

# USER

# MANUAL

S+M

RECOVERY

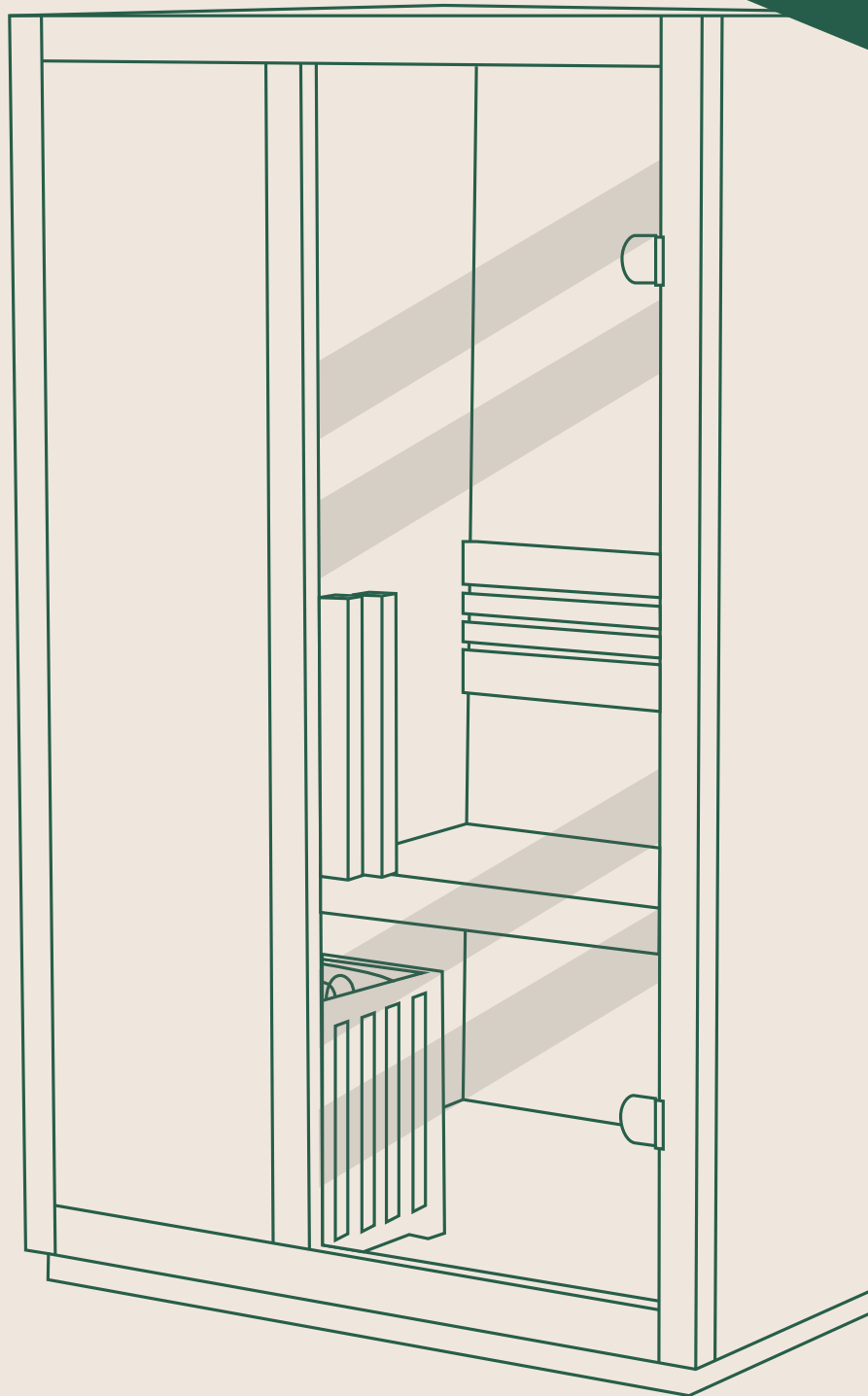

# Safety

## Please strictly follow safety precautions when using!

1. Children must be using the equipment under the care of an adult. For safety, do not play with it;
2. Do not insert objects such as fingers or sticks into the heating tube plate to prevent danger;
3. Never pour water to the equipment or the heating pipe (board);
4. Do not use or store flammable gas or liquid such as hair spray, oil paint, gasoline, etc near the equipment to avoid fire;
5. Do not place items inside or on top of the sauna;
6. Do not touch the power control panel and any electrical components with wet hands to prevent electric shock;
7. It is forbidden to use the equipment during thunderstorms to prevent electric shock;
8. Do not tilt the equipment, do not use sharp objects to strike;
9. Shut down the equipment for half an hour after 4 hours continuous working;
10. Do not operate the equipment in a long-term high temperature environment;
11. Use with caution after drinking alcohol;
12. Those who have hemophilia or are prone to bleeding should avoid using it;
13. Please consult your doctor before using if you are in period of disease and taking medicine;
14. Do not use after intense exercise, wait until the body temperature returns to normal before using;
15. If you feel any discomfort, please stop using immediately;
16. Mind your head when get in and out of the equipment;
17. Do not sleep inside the equipment when it is working;
18. Do not use any bath products in the sauna;
19. To avoid burns, do not touch the heating element;
20. Please keep the seat timber dry to avoid damage!
21. Please keep the floor heater dry to avoid excessive sweat dripping off!
22. **WARNING:**Covering the heater or infrared emitter causes fire risk!
23. If you have any questions, please call the supplier.

# Structure (Indoor Unit - 2 person)

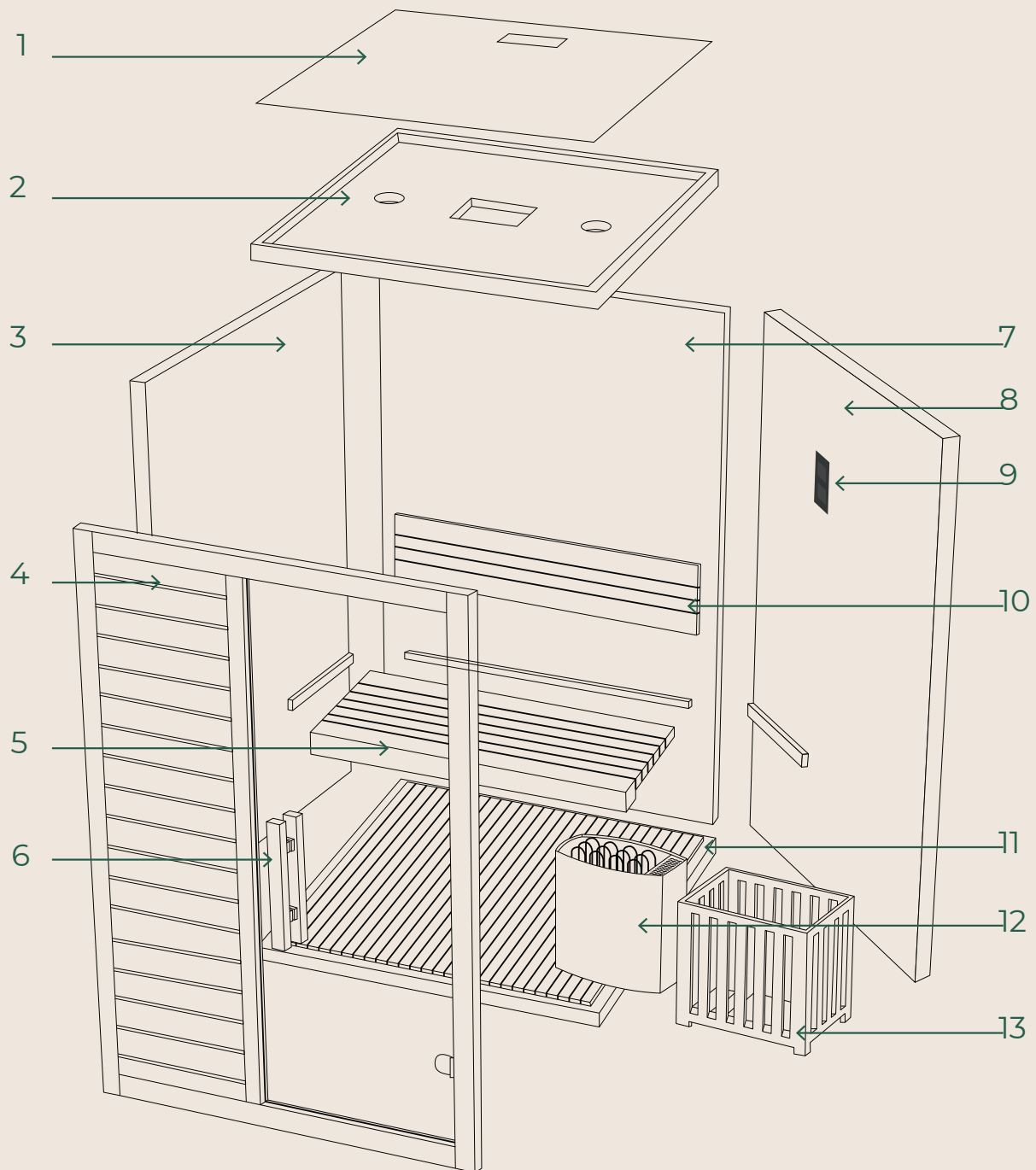

1. Duster Cover  
4. Front Board  
7. Back Board  
10. Backrest  
13. Stove Frame

2. Top Board  
5. Bench  
8. Right Board  
11. Bottom Board

3. Left Board  
6. Handle  
9. Control Panel  
12. Sauna Stove

# Installation Process

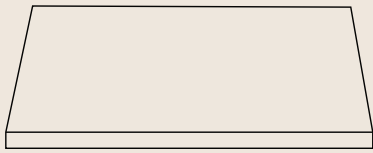

1. Bottom Board

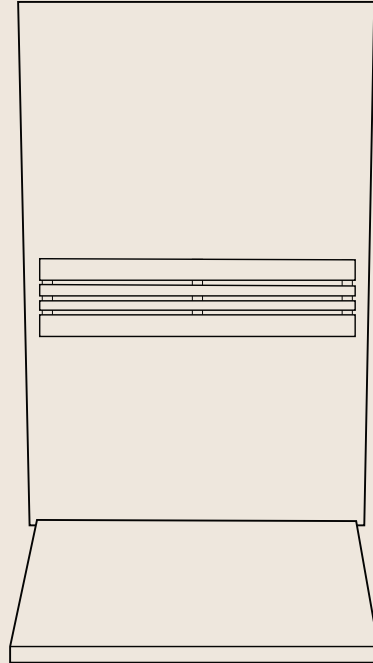

2. Back Board

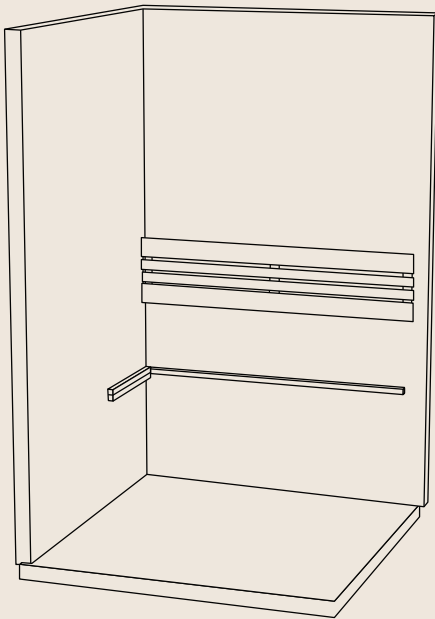

3. Left Board

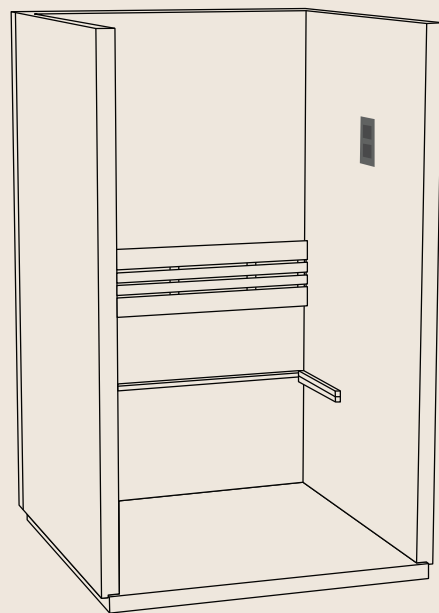

4. Right Board

The structure may vary from different models. Due to our continued product improvement, product illustrated on this instruction manual may vary slightly from the actual product.

# Installation Process

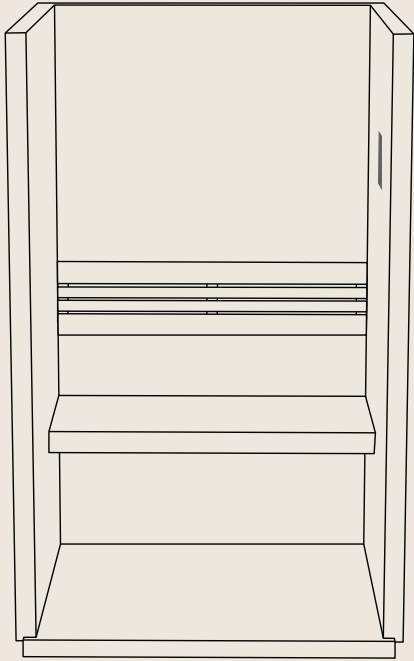

5. Bench

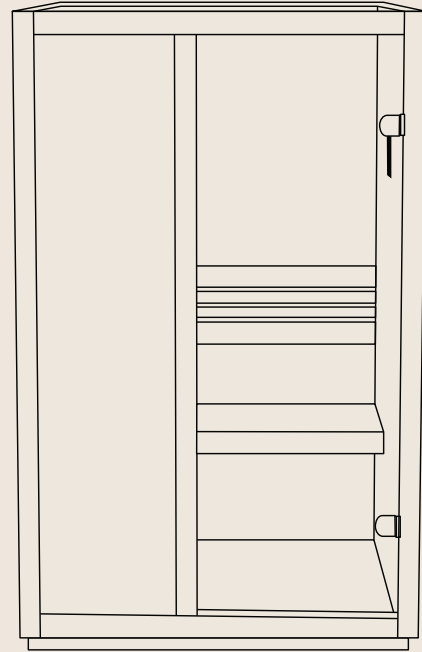

6. Front Board

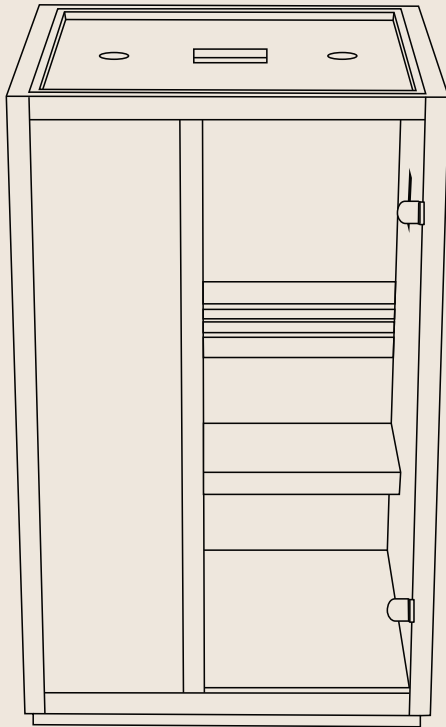

7. Top Board

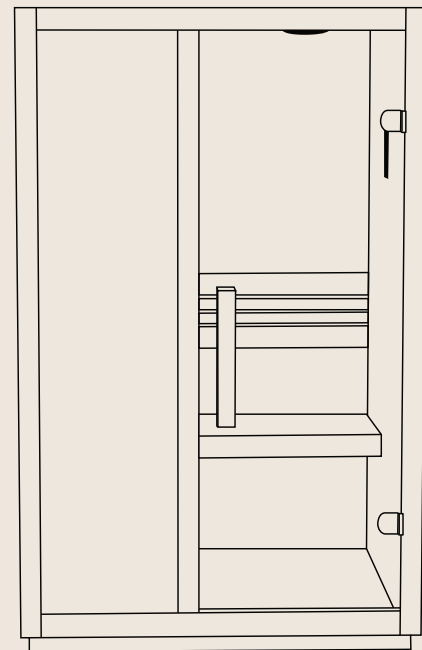

8. Handle

# Installation Process

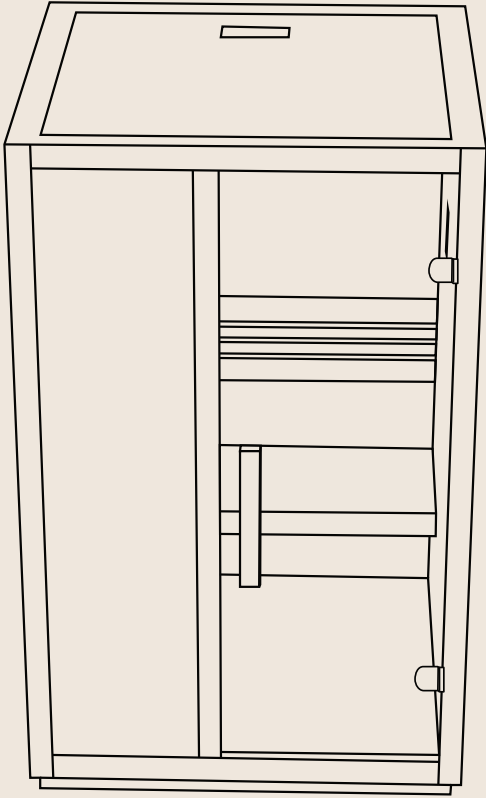

9. Duster Cover

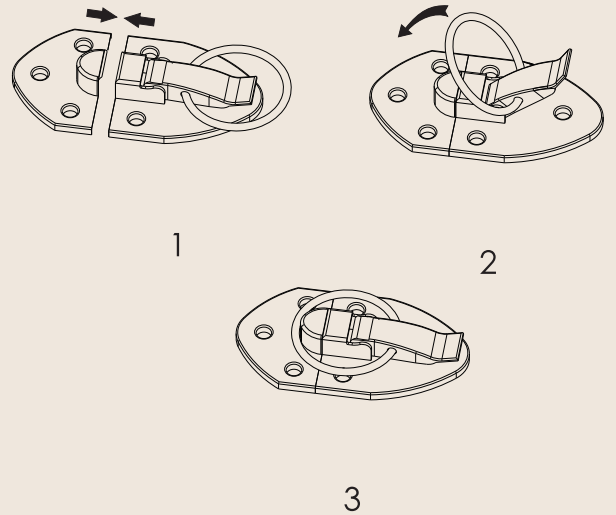

Outer buckle installation method

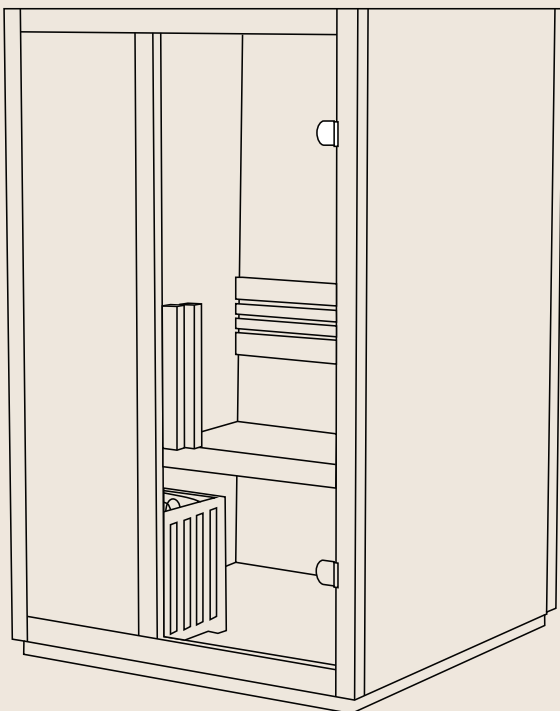

10. Stove Frame

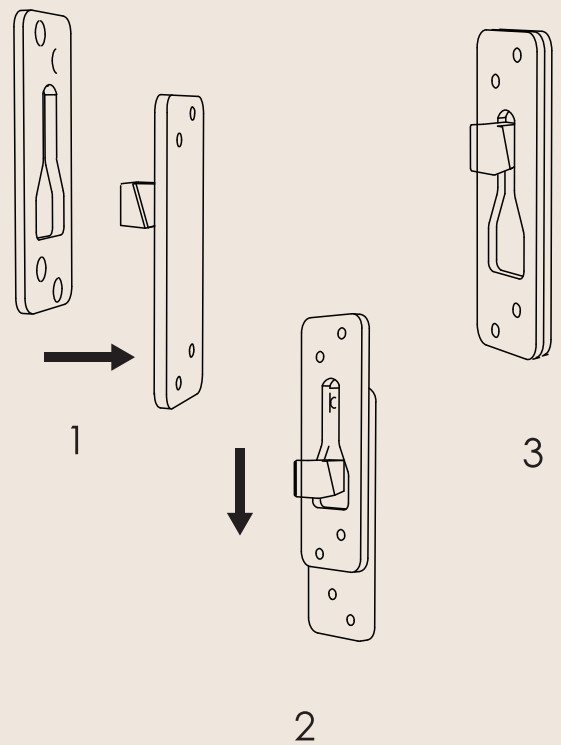

Hanging buckle installation method

# Structure (Indoor Unit - 4 person)

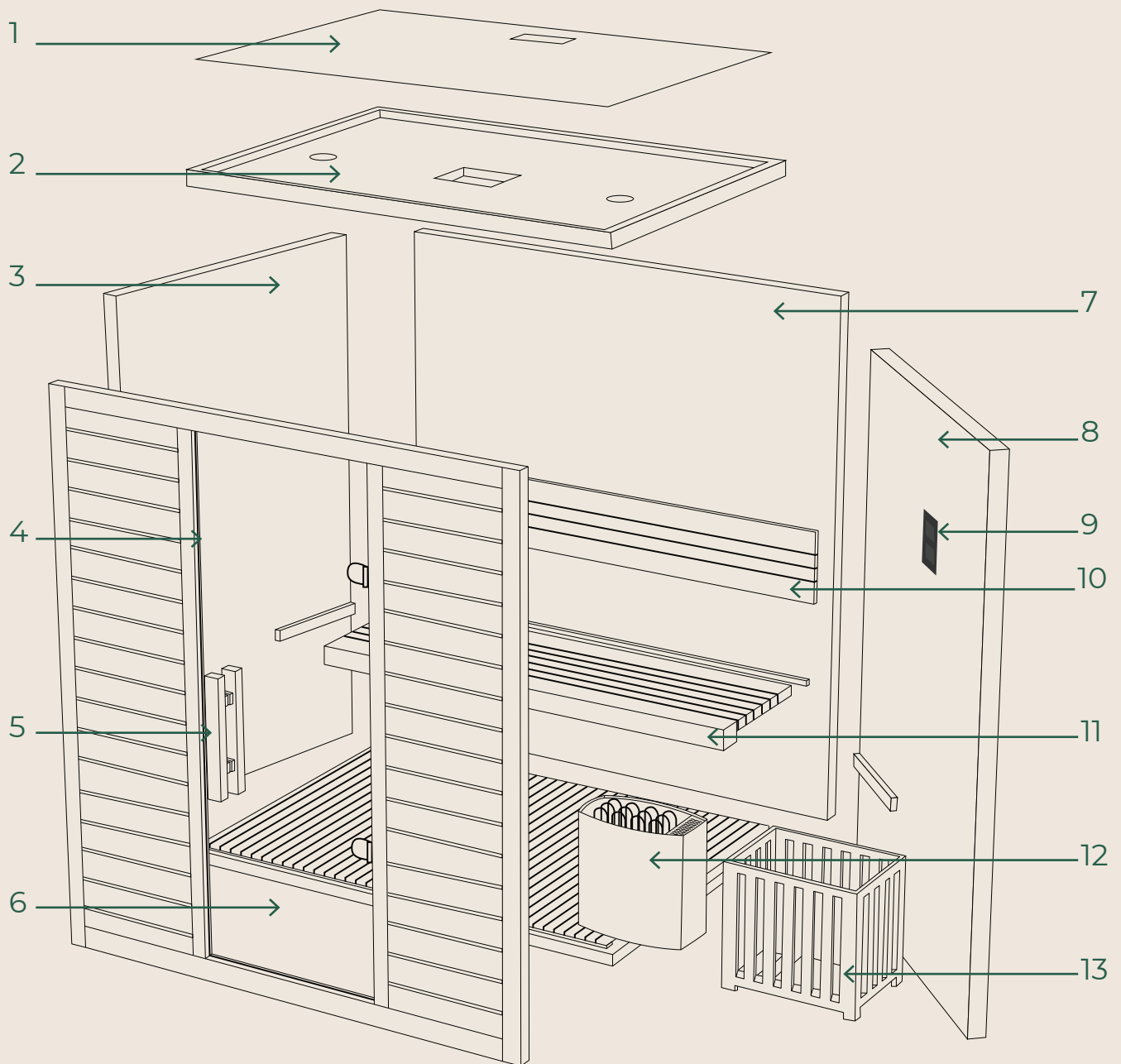

1. Duster Cover  
4. Front Board  
7. Back Board  
10. Backrest  
13. Stove Frame

2. Top Board  
5. Handle  
8. Right Board  
11. Bench

3. Left Board  
6. Bottom Board  
9. Control Panel  
12. Sauna Stove



# Installation Process

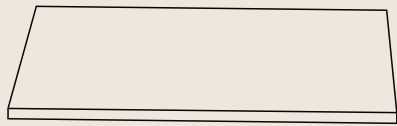

1. Bottom Board

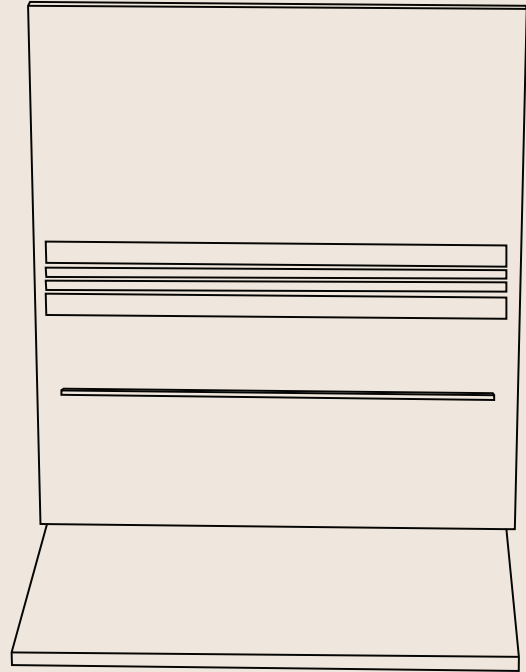

2. Back Board

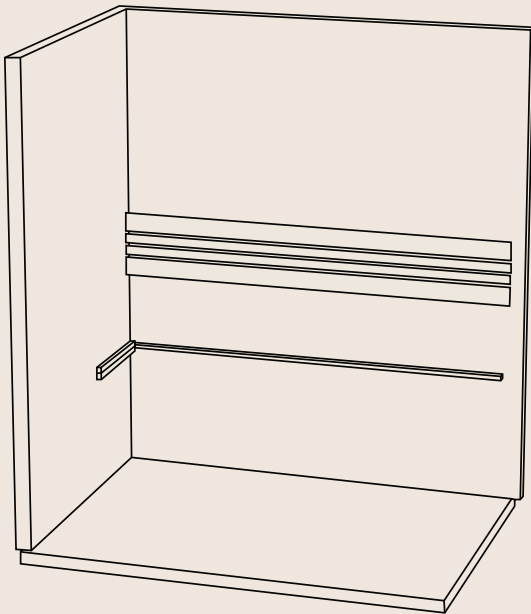

3. Left Board

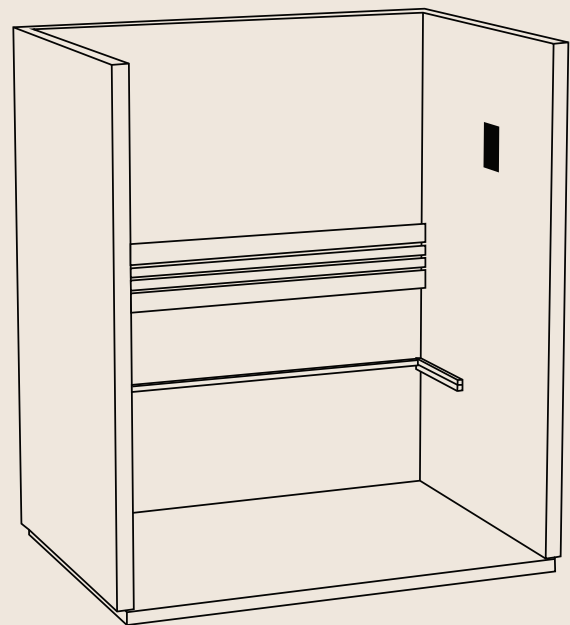

4. Right Board

The structure may vary from different models. Due to our continued product improvement, product illustrated on this instruction manual may vary slightly from the actual product.

# Installation Process

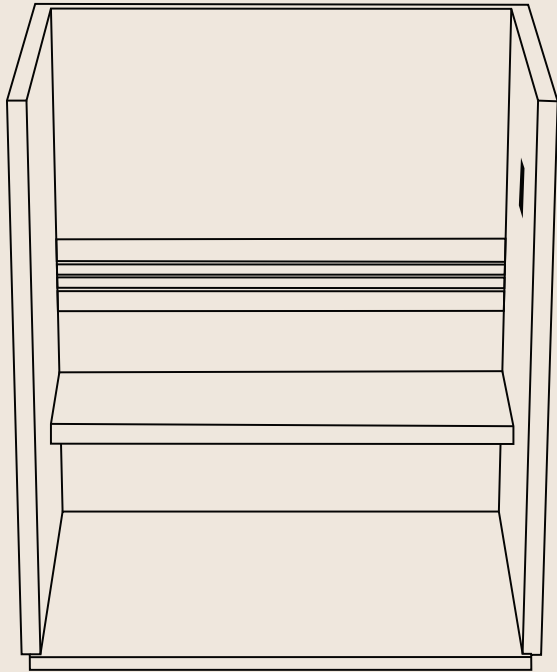

5. Bench

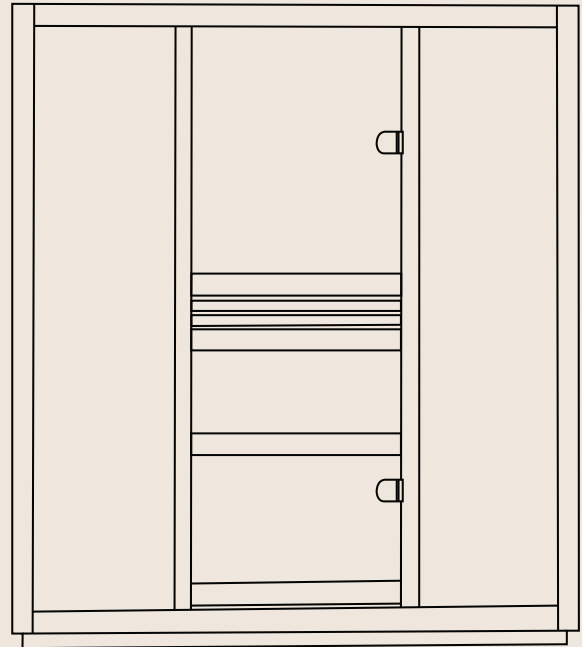

6. Front Board

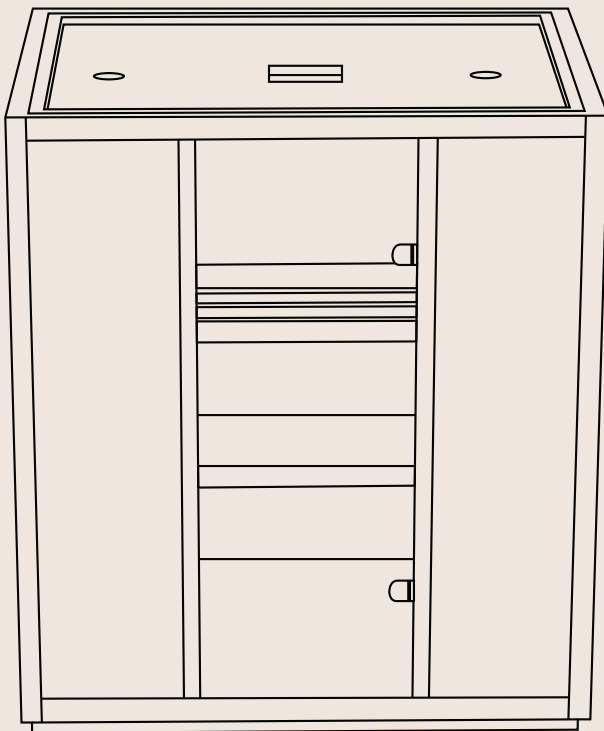

7. Top Board

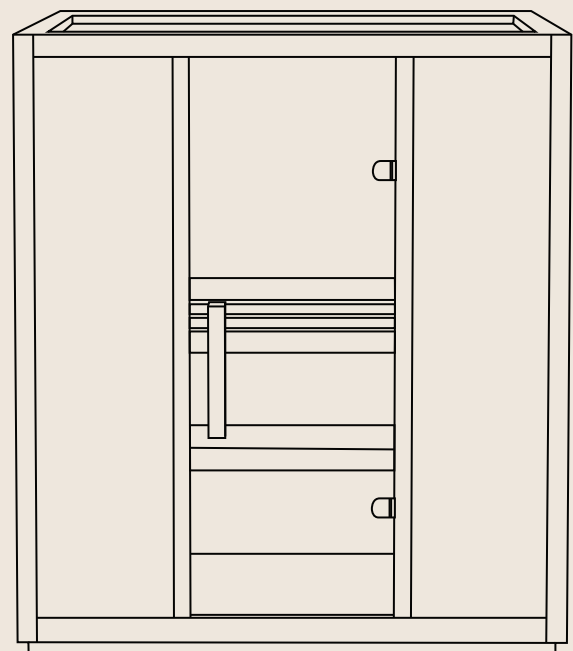

8. Handle

# Installation Process

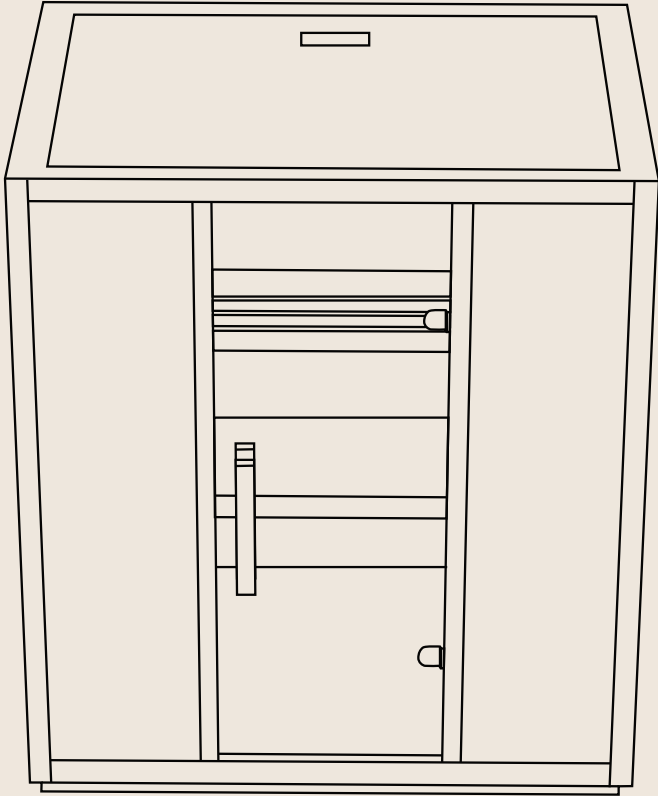

9. Duster Cover

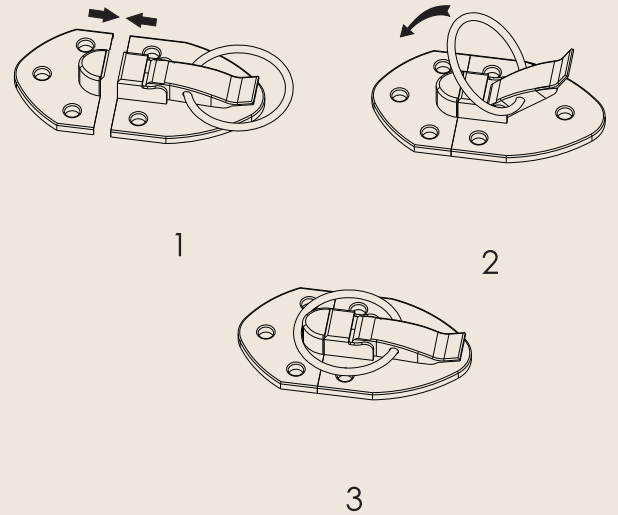

Outer buckle installation method

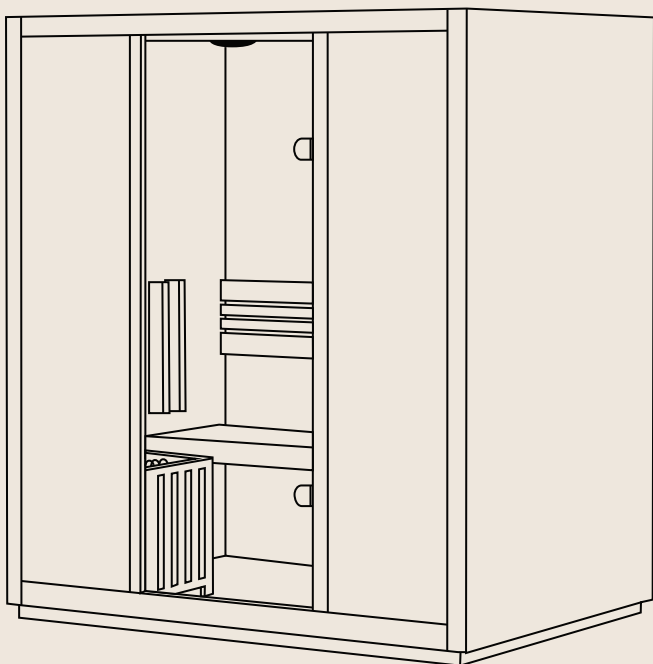



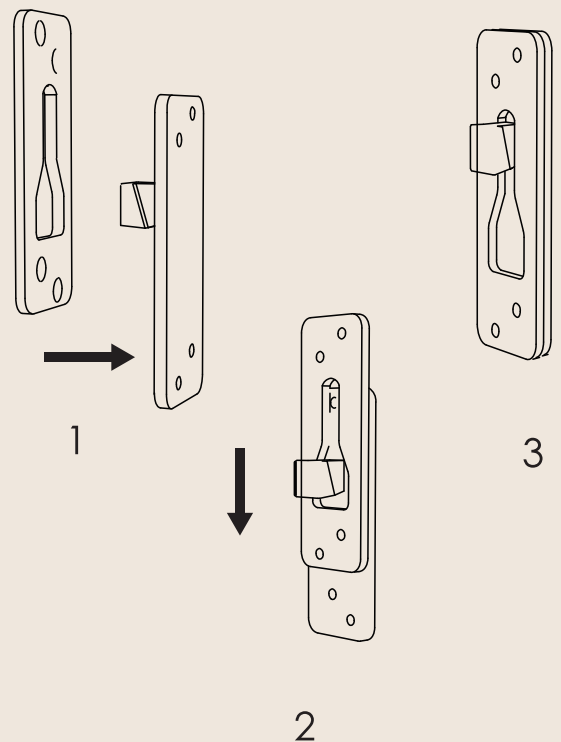

10. Stove Frame









Hanging buckle installation method

# 319 Controller Manual



1.  Power on and off
2.  Sauna heating switch, press after turning on  Turn on the heating function and adjust the setting time and temperature.
3.  Interior and exterior lights and colorful light switches, short press to switch on and off the inner and outer lights at the same time, long press for 3 seconds to enter the colorful light adjustment mode 1-7 for monochrome 8 is off 9 is to automatically switch colors, and automatically exit the colorful light mode after 3 seconds of no operation.

# 319 Controller Manual

4.  Countdown time setting plus, short press to fine-tune the countdown time setting plus, long press quick setting.
5.  Countdown time setting minus, short press to fine-tune countdown time setting minus, long press quick setting.
6.  Celsius/Fahrenheit toggle button, short press to switch in degrees Celsius/Fahrenheit.
7.  Mode switch key, short press this button to switch (Shaping Mode 1: 55 degrees for 90 minutes), (Detox Mode 2: 45 degrees 60 minutes) (Relax Mode 3: 50 degrees 60 minutes) (Beauty Mode 4: 45 degrees 90 minutes) (Soothe Mode 5: 40 degrees 30 minutes).
8.  Temperature setting plus, short press to fine-tune the temperature setting plus, long press to quickly set.
9.  The temperature setting is reduced, the short press is pressed to fine-tune the temperature setting is reduced, and the long press is quick to set.
10.  Bluetooth function icon, turn on the phone's bluetooth, search for bluetooth (bluetooth name is SAUNA BT) after searching, click to connect to Bluetooth, after connecting, the machine Bluetooth icon will light up and the machine will emit a 'ding-dong' sound. After connecting, open the phone player to play music.

# Controller App Manual



Android Link



ios Link

# Controller App Manual

Mobile phone app connection: Mobile need scan the QR code, intall the app. open the app after the installation, connection according below point 10 method

- 1.**Power Button: Switch on and off the machine.
- 2.**Temperature +/Previous track/Radio upwards search. In the heating mode, press the button to set the temperature up. In the play mode, this button is for previous music. In the radio mode, the button is for upwards chanel search.
- 3.** Temperature -/next track/Radio downward search. In the heating mode, press the button to set the temperature down. In the play mode, this button is for next music. In the radio mode, this button is for downward chanel search.
- 4.**Time +/ volume + button. The heating mode, press the button set the time increase.
- 5.** Time -/ volume - button. The heating mode, press the button set the time reduction.
- 6.** Volume +/- button. Adjust the volume increase or reduction when playing.
- 7.** RGB button: press this button to turn on the RGB phototherapy light(Colored Star Lights Or Colored Light Belt or Colored Phototherapy Lamp). Press 1-7 times to select the color of the phototherapy light, press the 8th button to turn off the interior phototherapy light, and press the 9th button to enter the color auto cycle model.
- 8.** Turn on the internal reading lamp and then turn it off.
- 9.** Turn on the external light(Roof Light) and then turn it off. (Optional)
- 10.** BT Connection button: Search "Sauna BT-APP" and connect mobile bluetooth.
- 11.** Press the FM button to enter the radio mode, and press the "temperature + or -" button to search the channel for 5 seconds. This opportunity will jump to the heating mode automatically.